



IT CATALOGO RICAMBI COMPATIBILI

EN REPLACEMENT WEAR PARTS CATALOGUE

FR CATALOGUE CONSOMMABLES COMPATIBLES

ES CATALOGO DE REPUESTOS COMPATIBLES

2016 2017





IT Il Gruppo Trafimet

Trafimet Group è un marchio italiano presente nel mercato industriale da quasi 40 anni che opera nello sviluppo e commercializzazione di prodotti e applicazioni per tutte le tecnologie di saldatura e taglio plasma.

Il Gruppo Trafimet si presenta a livello internazionale con filiali e partner locali che promuovono le sue tre fondamentali linee di business.

La divisione PRO di Trafimet Group nasce per realizzare prodotti di alta gamma, professionali e ad elevata tecnologia per applicazione sui migliori generatori presenti nel mercato.

Grazie ad un'attenta e precisa definizione dei criteri di progetto per il centro di ricerca e sviluppo Trafimet Group, una oculata produzione realizzata con impianti all'avanguardia della tecnica e tecnologia, una sempre costante attenzione al cliente, la divisione PRO di Trafimet Group punta a garantire al cliente il massimo in termini di tecnologia e qualità percepita sotto tutti i punti di vista.

Solo con un team di professionisti tra i più preparati al mondo, possiamo confermare che tutte le attese del cliente e del mercato saranno soddisfatte ai massimi livelli.

EN Trafimet Group

Trafimet Group is an Italian brand, existing on the industrial market for nearly 40 years, is one of the world leaders in the development and marketing of products and applications for all welding and plasma cutting technologies.

Trafimet Group is managed at international level with branches and local partners, to promote its three lines of business.

Trafimet Group PRO business unit was born to manufacture high technology and quality professional products, to be used by the best power sources available on the market.

Thanks to a careful and precise definition of design criteria to Trafimet Group R&D department, a careful production made in high level and advanced facilities where a continuous testing of components produced and careful to the customer is the rule, Trafimet Group PRO aims to provide the ultimate in technology and perceived quality from all points of view to all customers.

Only with a team of professionals among the most qualified in the world, we can confirm that all the market expectation will be met at the highest level.

FR Le Groupe Trafimet

Trafimet Group est une société italienne présente sur le marché international depuis presque 40 ans. Elle développe et commercialise des produits et des applications pour toutes les technologies de soudage et coupeage plasma.

Avec ses filiales ou ses partenaires locaux, Trafimet Groupe développe, au niveau international, trois lignes principales de business.

Trafimet Group PRO – c'est la division qui a pour but de réaliser et distribuer des produits de haute technologie, destinés à être utilisés avec des machines de hautes performances et pour des applications très spécifiques.

Les techniques et technologies, aujourd'hui possédées par la division PRO de Trafimet Group, garanties à tous clients le maximum de qualité et prestations de ses produits.

Avec ses équipes, entre les plus performantes dans son domaine, Trafimet Group garantie les réponses et les solutions aux questions de ses clients à tous les niveaux.

ES El Grupo Trafimet

Trafimet Group es una marca italiana presente en el mercado industrial desde hace casi 40 años que trabaja en el desarrollo y comercialización de productos y aplicaciones para todas las tecnologías de soldadura y corte por plasma.

El Grupo Trafimet se presenta a nivel internacional con filiales y socios locales que promocionan sus tres líneas de negocio.

La división PRO de Trafimet Group nació para lograr productos de alta calidad, profesionales y de alta tecnología para la aplicación en los mejores generadores presentes en el mercado.

Gracias a una definición cuidadosa y precisa de los criterios de diseño para el centro de investigación y desarrollo Trafimet Group, una prudente producción hecha con maquinarias con la máxima técnica y tecnología una atención constante al cliente, la división PRO de Trafimet Group quiere garantizar a sus clientes lo último en tecnología y calidad percibida en virtud de todos los puntos de vista.

Sólo con un equipo de profesionales, incluyendo los mejores preparados en el mundo, podemos confirmar que todas las expectativas de los clientes y el mercado serán satisfechas con el nivel más alto.

IT

“Il vero compatibile non è la semplice copia di un ricambio, ma diventa l’interpretazione tecnica di un elemento che grazie ai più elevati standard qualitativi, si integrerà perfettamente ai migliori generatori.”

da Trafimet Pro

EN

“The real compatible is not a simple spare part but it’s a technical interpretation of highest quality standard element that will perfectly be integrated on the best power sources.”

by Trafimet Pro

FR

“La vraie pièce compatible n’est pas simplement la copie d’une pièce originale, mais elle est l’interprétation technique d’un élément qui, grâce aux grands standards de haute qualité, s’intègre parfaitement ses originaux.”

par Trafimet Pro

ES

“El compatible real no es simplemente una copia de un reemplazo, pero se hace la interpretación técnica de un elemento con los más altos estándares de calidad que se integrará a la perfección a los mejores generadores.”

por Trafimet Pro

Richiedi una campionatura!

Ask for samples!

Demandez un échantillonnage!

Pregunta por muestras!

trafimetpro.com



Dal 1999 Trafimet Group è certificata
DIN EN ISO 9001.

Since 1999 Trafimet Group has been certified
DIN EN ISO 9001.

Trafimet Group est certifiée
DIN EN ISO 9001 depuis 1999.

Desde el 1999 Trafimet Group esta certificada
DIN EN ISO 9001.

HYPERTHERM®	
Powermax 600® - 800® - 900®	6
Powermax 1000® - 1250® - 1650®	8
MAX 200®	10
HPR 130® - HD 3070® UPGRADE	12
HPR 130® XD	14
HPR 260® - HD 4070® UPGRADE	16
HPR 260® XD	18
SAF® - FRO®	
CP 40R - CP 100R	20
OCP 150 - O2	22
OCP 150 - N2-Ar/H2	24
OTC®	
D - 8000	26
D - 12000	28
THERMAL DYNAMICS®	
Dynapak 110® - PAK 2XT®	30
PakMaster® 25 - EconoPak® 25	32
Stak Pak® 35 - PakMaster® 50	34
PAX® 3XR-5XR-5XT-6XR-625XR-750XR - Dynapak® 4xi - 6xi	36
PAX® 5XR-6XR-7XR-8XR-10XR-625XR-750XR-1000XR-1250XR	38
PakMaster® 75XL Plus	40
STAK PAK®	42
PakMaster® 75-75XL-100XL Plus - EconoPak® 100	44
EconoPak® 100	46
PakMaster® 100XL Plus	48
PAK®10XR	50
TEC.MO.®	
PT 40	52
PT 60	54
PT 80	56
PT 100	58

Confezionamento - Packaging - Emballage - Embalaje	60
Espositore - Display materials - Présentoir - Expositor	61
Condizioni generali di vendita - General terms of sale	
Conditions générales de vente - Condiciones generales de venta	62

Soluzione in blister - Blister's solution - Solution en blisters - Solución en blister

Powermax 600® (PAC 123T/M)

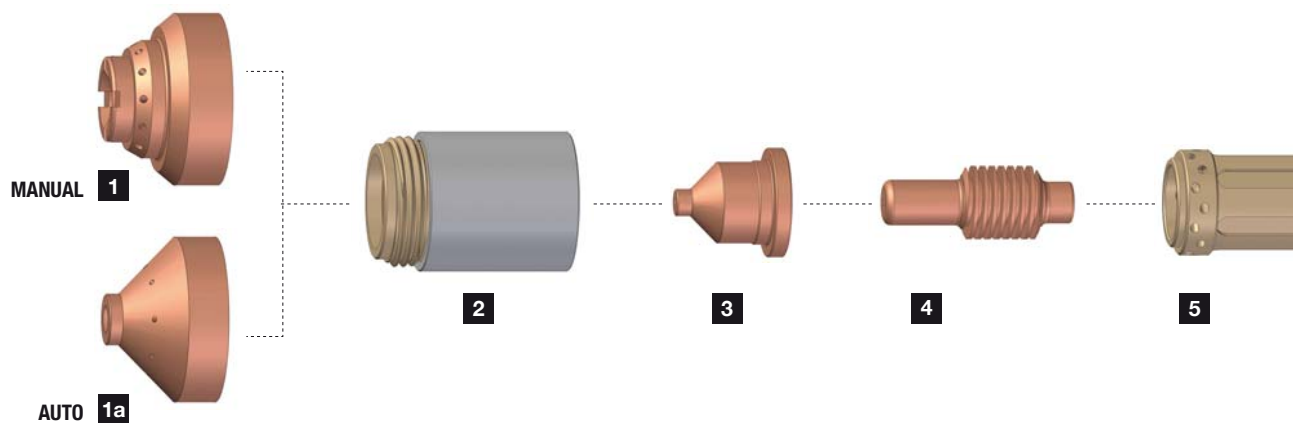

Powermax 800® (PAC 121TS/M) (PAC 125T/M)

Powermax 900® (PAC 125T/M)





CODE	A	600	800	900	REF	Pcs X 	 X 
------	---	-----	-----	-----	-----	--	---

1 SCHERMO MAN - SHIELD MAN - PATIN MAN - ESCUDO MAN

CV0108P		40	•			T120828H	1	2
CV0106P		40 55		•	•	T120601H	1	2





1a SCHERMO AUT - SHIELD AUT - PATIN AUT - ESCUDO AUT

CV0107P		40	•			T120827H	1	2
CV0183P		40 55		•	•	T120602H	1	2

2 UGELLO PORTA SCHERMO - RETAINING CAP - BUSE PROTECTION - TOBERA DE RETENCIÓN

PC0087P		55	•	•	•	T120600H	1	2
---------	---	----	---	---	---	----------	---	---

3 CAPPÀ - NOZZLE - TUYÈRE - BOQUILLA



PD0133P10		40	•			T120826H	5	2
PD0083P10		40		•		T120438H	5	2
PD0083P11		50		•		T120282H	5	2
PD0145P10		55			•	T120577H	5	2

CODE	A	600	800	900	REF	Pcs X 	 X 
------	---	-----	-----	-----	-----	--	---

4 ELETTRODO - ELECTRODE - ELECTRODE - ELECTRODO

PR0133P		40 55	•	•	•	T120573H	5	2
---------	---	----------	---	---	---	----------	---	---

5 DIFFUSORE VESPEL - SWIRL RING VESPEL - DIFFUSEUR VESPEL - DIFFUSOR VESPEL

PE0299P		40 55	•		•	T120576H	1	2
PE0300P		40 50		•		T020361H	1	2

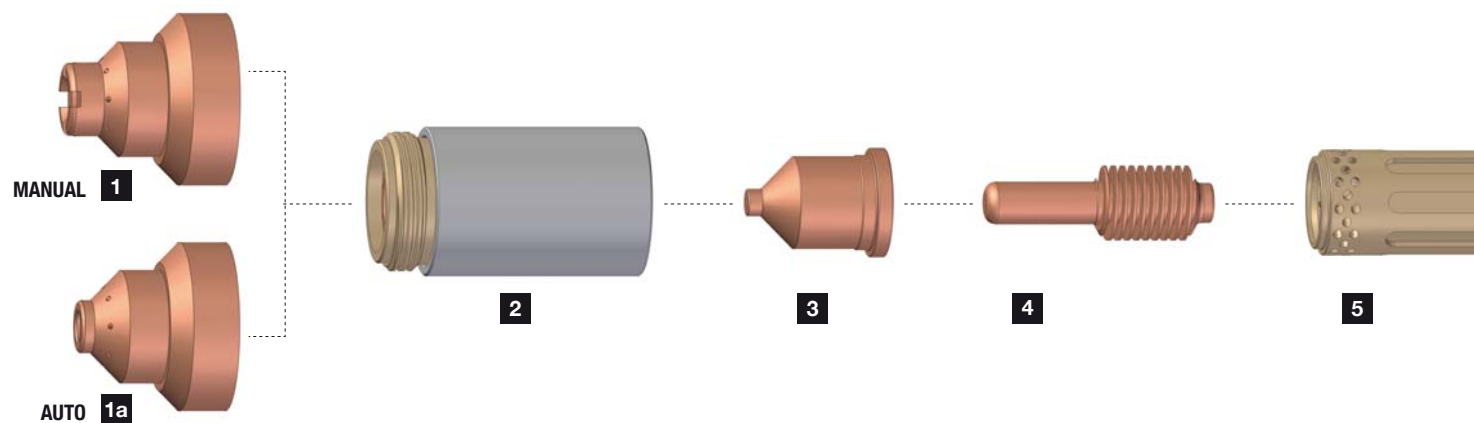

Soluzione in blister - Blister's solution - Solution en blisters - Solución en blister

Powermax 1000®	(T60M)
Powermax 1250®	(T80M)
Powermax 1650®	(T100/M/M-2)





CODE		A	1000	1250	1650	REF	Pcs X			
------	--	---	------	------	------	-----	-------	--	--	--



1 SCHERMO MAN - SHIELD MAN - PATIN MAN - ESCUDO MAN

CV0176P		40 60 80	•	•	•	T120929H	1			2
CV0178P		100			•	T220065H	1			2





1a SCHERMO AUT - SHIELD AUT - PATIN AUT - ESCUDO AUT

CV0177P		40 60 80	•	•	•	T120930H	1			2
CV0179P		100			•	T220047H	1			2

2 UGELLO PORTA SCHERMO - RETAINING CAP - BUSE PROTECTION - TOBERA DE RETENCIÓN



PC0234P		40 60 80	•	•	•	T120928H	1			2
PC0233P		100			•	T220048H	1			2

3 CAPPA - NOZZLE - TUYÈRE - BOQUILLA



PD0234P10		40	•	•	•	T120932H	5			2
PD0234P12		60	•	•	•	T120931H	5			2
PD0234P14		80		•	•	T120927H	5			2
PD0233P16		100			•	T220011H	5			2

CODE		A	1000	1250	1650	REF	Pcs X			
------	--	---	------	------	------	-----	-------	--	--	--

4 ELETTRODO - ELECTRODE - ELECTRODE - ELECTRODO

PR0234P		40 60 80	•	•	•	T120926H	5			2
PR0233P		100			•	T220037H	5			2

5 DIFFUSORE VESPEL - SWIRL RING VESPEL - DIFFUSEUR VESPEL - DIFFUSOR VESPEL

PE0234P		40 60 80	•	•	•	T120925H	1			2
PE0233P		100			•	T220051H	1			2

Soluzione in blister - Blister's solution - Solution en blisters - Solución en blister

Max 200®

(PAC 200T/M)

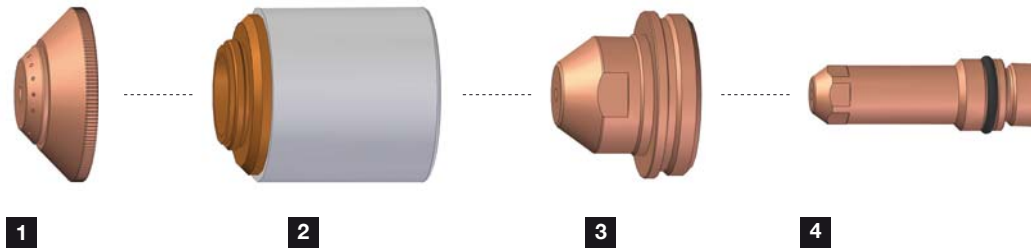

MS Acciaio al carbonio
SS Acciaio inossidabile
AL Alluminio



MS Mild Steel
SS Stainless Steel
AL Aluminium

MS Acier au carbone
SS Acier inoxydable
AL Aluminium

MS Acero carbon
SS Acero inoxidable
AL Aluminio

CODE		A	MS	SS	AL	REF	Pcs X 	 X 
------	--	---	----	----	----	-----	--	---





1 SCHERMO AUT - SHIELD AUT - PATIN AUT - ESCUDO AUT

CV1111P		100	•	•	•	T020448H	1	2
CV1115P		200	•	•	•	T020424H	1	2



2 UGELLO PORTA SCHERMO - RETAINING CAP - BUSE PROTECTION - TOBERA DE RETENCIÓN

PC0027P		100 200	•	•	•	T020423H	1	1
---------	---	------------	---	---	---	----------	---	---

3 CAPPA - NOZZLE - TUYÈRE - BOQUILLA

PD0072P10		40	•			T020689H	1	2
PD0068P15		100	•		•	T020611H	1	2
PD0306P22		200	•		•	T020608H	1	2
PD0071P14		100		•		T020616H	1	2
PD0070P20		200		•		T020605H	1	2

4 ELETTRODO - ELECTRODE - ELECTRODE - ELECTRODO

PR0307P		100	•	•		T120547H	1	2
PR0305P		200	•	•		T220021H	1	2

Soluzione in blister - Blister's solution - Solution en blisters - Solución en blister

HPR 130®

(HPR 130® torch)

HD 3070®

UPGRADE HD 3070® torch

* NOTA IMPORTANTE: I NOSTRI ELETTRDI (6) DEVONO ESSERE UTILIZZATI CON IL NOSTRO TUBETTO DI RAFFREDDAMENTO (7)

* IMPORTANT NOTE: OUR ELECTRODES (6) MUST BE USED WITH OUR WATER COOLING TUBE (7)

* IMPORTANT: NOS ÉLECTRODES (6) DOIVENT ÊTRE UTILISÉES UNIQUEMENT AVEC NOTRE TUBE PLONGEUR (7)

* ATENCIÓN: NUESTROS ELECTRODOS (6) TIENES QUE SER UTILIZADOS CON NUESTRO TUBO DE REFRIGERACIÓN (7)

MS Acciaio al carbonio

SS Acciaio inossidabile

AL Alluminio

MS Mild Steel

SS Stainless Steel

AL Aluminium

MS Acier au carbone

SS Acier inoxydable

AL Aluminium

MS Acero carbon

SS Acero inoxidable





AL Aluminio

CODE	A	MS	SS	AL	REF	Pcs X			
------	---	----	----	----	-----	-------	--	--	--



1 COPRI SCHERMO - SHIELD CAP - PROTECTION PATIN - ESCUDO DE COBERTURA

CV0255P		30 50 80 130	•	•	•	T220173H	1		1
---------	---	-----------------------	---	---	---	----------	---	--	---



2 SCHERMO - SHIELD - PATIN - ESCUDO

CV0260P		30	•			T220194H	1		2
CV0259P		50	•			T220555H	1		2
CV0261P		80	•			T220189H	1		2
CV0262P		130	•			T220183H	1		2



3 UGELLO PORTA SCHERMO - RETAINING CAP - BUSE PROTECTION - TOBERA DE RETENCIÓN

PC0260P		30 50	•			T220313H	1		1
PC0261P		80 130	•			T220176H	1		1



4 CAPPA - NOZZLE - TUYÈRE - BOQUILLA

PD0260P06		30	•			T220193H	1		2
PD0259P08		50	•			T220554H	1		2
PD0261P12		80	•			T220188H	1		2





CODE	A	MS	SS	AL	REF	Pcs X			
------	---	----	----	----	-----	-------	--	--	--

PD0262P13		100	•			T220510H	1		2
PD0262P14		130	•			T220182H	1		2

5 DIFFUSORE - SWIRL RING - DIFFUSEUR - DIFFUSOR

PE0260P		30 45	•	•	•	T220180H	1		2
PE0259P		50	•			T220553H	1		2
PE0261P		80 130	•	•	•	T220179H	1		2

6 ELETTRODO - ELECTRODE - ELECTRODE - ELECTRODO

PR0260P		30	•			T220192H	1		2
PR0259P		50	•			T220552H	1		2
PR0261P		80	•			T220187H	1		2
PR0262P		130	•			T220181H	1		2

7 TUBETTO RAFFREDDAMENTO - COOLING TUBE - TUBE DE REFRIGERISSEMENT - TUBO DE REFRIGERACIÓN

FH0809P			•	•	•	T220340H	1		2
---------	---	--	---	---	---	----------	---	--	---

Soluzione in blister - Blister's solution - Solution en blisters - Solución en blister

HPR 130® XD

(HPR 130® XD torch)



* NOTA IMPORTANTE: I NOSTRI ELETTRDI (6) DEVONO ESSERE UTILIZZATI CON IL NOSTRO TUBETTO DI RAFFREDDAMENTO (7)

* IMPORTANT NOTE: OUR ELECTRODES (6) MUST BE USED WITH OUR WATER COOLING TUBE (7)

* IMPORTANT: NOS ÉLECTRODES (6) DOIVENT ÊTRE UTILISÉES UNIQUEMENT AVEC NOTRE TUBE PLONGEUR (7)

* ATENCIÓN: NUESTROS ELECTRODOS (6) TIENES QUE SER UTILIZADOS CON NUESTRO TUBO DE REFRIGERACIÓN (7)

MS Acciaio al carbonio
SS Acciaio inossidabile
AL Alluminio

MS Mild Steel
SS Stainless Steel
AL Aluminium

MS Acier au carbone
SS Acier inoxydable
AL Aluminium





MS Acero carbon
SS Acero inoxidable
AL Aluminio

CODE		A	MS	SS	AL	REF	Pcs X 	 X 
------	--	---	----	----	----	-----	--	---



1 COPRI SCHERMO - SHIELD CAP - PROTECTION PATIN - ESCUDO DE COBERTURA

CV0256P		30 50 80 130	•	•	•	T220747H	1	1
---------	---	-----------------------	---	---	---	----------	---	---





2 SCHERMO - SHIELD - PATIN - ESCUDO

CV0260P		30	•			T220194H	1	2
CV0259P		50	•			T220555H	1	2
CV0261P		80	•			T220189H	1	2
CV0262P		130	•			T220183H	1	2

3 UGELLO PORTA SCHERMO - RETAINING CAP - BUSE PROTECTION - TOBERA DE RETENCIÓN



PC0262P		30 50	•			T220754H	1	1
PC0263P		80 130	•			T220756H	1	1

4 CAPPÀ - NOZZLE - TUYÈRE - BOQUILLA





PD0260P06		30	•			T220193H	1	2
PD0259P08		50	•			T220554H	1	2
PD0261P12		80	•			T220188H	1	2
PD0262P14		130	•			T220182H	1	2

CODE		A	MS	SS	AL	REF	Pcs X 	 X 
------	--	---	----	----	----	-----	--	---

5 DIFFUSORE - SWIRL RING - DIFFUSEUR - DIFFUSOR

PE0260P		30 45	•	•	•	T220180H	1	2
PE0259P		50	•			T220553H	1	2
PE0261P		80 130	•	•	•	T220179H	1	2

6 ELETTRODO - ELECTRODE - ELECTRODE - ELECTRODO

PR0260P		30	•			T220192H	1	2
PR0259P		50	•			T220552H	1	2
PR0261P		80	•			T220187H	1	2
PR0262P		130	•			T220181H	1	2

7 TUBETTO RAFFREDDAMENTO - COOLING TUBE - TUBE DE REFRROIDISSEMENT - TUBO DE REFRIGERACIÓN

FH0809P			•	•	•	T220340H	1	2
---------	---	--	---	---	---	----------	---	---

Soluzione in blister - Blister's solution - Solution en blisters - Solución en blister

HPR 260®

(HPR 260® torch)

HD 4070®

UPGRADE HD 4070® torch

* NOTA IMPORTANTE: I NOSTRI ELETTRODI (6) DEVONO ESSERE UTILIZZATI CON IL NOSTRO TUBETTO DI RAFFREDDAMENTO (7)

* IMPORTANT NOTE: OUR ELECTRODES (6) MUST BE USED WITH OUR WATER COOLING TUBE (7)

* IMPORTANT: NOS ÉLECTRODES (6) DOIVENT ÊTRE UTILISÉES UNIQUEMENT AVEC NOTRE TUBE PLONGEUR (7)

* ATENCIÓN: NUESTROS ELECTRODOS (6) TIENEN QUE SER UTILIZADOS CON NUESTRO TUBO DE REFRIGERACIÓN (7)

MS Acciaio al carbonio

SS Acciaio inossidabile

AL Alluminio

MS Mild Steel

SS Stainless Steel

AL Aluminium

MS Acier au carbone

SS Acier inoxydable

AL Aluminium



MS Acero carbon

SS Acero inoxidable

AL Aluminio

CODE	A	MS	SS	AL	REF	Pcs X 	 X 
------	---	----	----	----	-----	--	---





1 COPRI SCHERMO - SHIELD CAP - PROTECTION PATIN - ESCUDO DE COBERTURA

CV0255P		30 50 80 130	•	•	•	T220173H	1	1
CV0257P		200 260	•	•	•	T220398H	1	1



2 SCHERMO - SHIELD - PATIN - ESCUDO

CV0260P		30	•			T220194H	1	2
CV0259P		50	•			T220555H	1	2
CV0261P		80	•			T220189H	1	2
CV0262P		130	•			T220183H	1	2
CV0263P		200	•			T220356H	1	2
CV0264P		260	•			T220440H	1	2

3 UGELLO PORTA SCHERMO - RETAINING CAP - BUSE PROTECTION - TOBERA DE RETENCIÓN

PC0260P		30 50	•			T220313H	1	1
PC0261P		80 130	•			T220176H	1	1
PC0264P		200	•			T220355H	1	1
PC0265P		260	•			T220433H	1	1





4 CAPPÀ - NOZZLE - TUYÈRE - BOQUILLA

PD0260P06		30	•			T220193H	1	2
PD0259P08		50	•			T220554H	1	2

Tutti i nomi e marchi sopra citati sono di esclusiva proprietà delle rispettive aziende. Trafimet Group non è affiliata in alcun modo ai marchi citati dei produttori.

All the above names and trademarks are of exclusive property of the respective companies. Trafimet Group is not way affiliated with the above-named manufactures.

CODE	A	MS	SS	AL	REF	Pcs X 	 X 
------	---	----	----	----	-----	--	---

PD0261P12		80	•			T220188H	1	2
PD0262P14		130	•			T220182H	1	2
PD0263P18		200	•			T220354H	1	2
PD0268P20		260	•			T220439H	1	2

5 DIFFUSORE - SWIRL RING - DIFFUSEUR - DIFFUSOR

PE0260P		30 45	•	•	•	T220180H	1	2
PE0259P		50	•	•	•	T220553H	1	2
PE0261P		80 130	•	•	•	T220179H	1	2
PE0262P		200	•	•	•	T220353H	1	2
PE0263P		260	•	•	•	T220436H	1	2

6 ELETTRODO - ELECTRODE - ELECTRODE - ELECTRODO

PR0260P		30	•			T220192H	1	2
PR0259P		50	•			T220552H	1	2
PR0261P		80	•			T220187H	1	2
PR0262P		130	•			T220181H	1	2
PR0263P		200	•			T220352H	1	2
PR0264P		260	•			T220435H	1	2

7 TUBETTO RAFFREDDAMENTO - COOLING TUBE - TUBE DE REFOUDDISSEMENT - TUBO DE REFRIGERACIÓN

FH0809P			•	•	•	T220340H	1	2
---------	---	--	---	---	---	----------	---	---

Tous les noms et marques commerciales, mentionnés ci-dessus, sont la propriété exclusive de leurs respectives sociétés. Trafimet Group n'est pas affilié en aucune façon aux marques des producteurs.

Todos los nombres y marcas comerciales mencionadas son propiedad de sus respectivas compañías. Trafimet Group no está afiliado de ninguna manera con las marcas de los fabricantes.

Soluzione in blister - Blister's solution - Solution en blisters - Solución en blister

HPR 260® XD

(HPR 260® XD torch)



* NOTA IMPORTANTE: I NOSTRI ELETTRDI
(6) DEVONO ESSERE UTILIZZATI CON IL NOSTRO
TUBETTO DI RAFFREDDAMENTO (7)

* IMPORTANT NOTE: OUR ELECTRODES (6) MUST
BE USED WITH OUR WATER COOLING TUBE (7)

* IMPORTANT: NOS ÉLECTRODES (6) DOIVENT
ÊTRE UTILISÉES UNIQUEMENT AVEC NOTRE TUBE
PLONGEUR (7)

* ATENCIÓN: NUESTROS ELECTRODOS (6)
TIENEN QUE SER UTILIZADOS CON NUESTRO TUBO
DE REFRIGERACIÓN (7)

MS Acciaio al carbonio

SS Acciaio inossidabile

AL Alluminio

MS Mild Steel

SS Stainless Steel

AL Aluminium

MS Acier au carbone

SS Acier inoxydable

AL Aluminium

MS Acero carbon

SS Acero inoxidable

AL Aluminio

CODE	A	MS	SS	AL	REF	Pcs X 	 X 
------	---	----	----	----	-----	--	---





1 COPRI SCHERMO - SHIELD CAP - PROTECTION PATIN - ESCUDO DE COBERTURA

CV0256P		30 50 80 130	•	•	•	T220747H	1	1
CV0258P		200 260	•	•	•	T220637H	1	1



2 SCHERMO - SHIELD - PATIN - ESCUDO

CV0260P		30	•			T220194H	1	2
CV0259P		50	•			T220555H	1	2
CV0261P		80	•			T220189H	1	2
CV0262P		130	•			T220183H	1	2
CV0265P		200	•			T220761H	1	2
CV0266P		260	•			T220764H	1	2

3 UGELLO PORTA SCHERMO - RETAINING CAP - BUSE PROTECTION - TOBERA DE RETENCIÓN

PC0262P		30 50	•			T220754H	1	1
PC0263P		80 130	•			T220756H	1	1
PC0266P		200	•			T220757H	1	1
PC0267P		260	•			T220760H	1	1





4 CAPPÀ - NOZZLE - TUYÈRE - BOQUILLA

PD0260P06		30	•			T220193H	1	2
PD0259P08		50	•			T220554H	1	2

Tutti i nomi e marchi sopra citati sono di esclusiva proprietà delle rispettive aziende. Trafimet Group non è affiliata in alcun modo ai marchi citati dei produttori.

All the above names and trademarks are of exclusive property of the respective companies. Trafimet Group is not way affiliated with the above-named manufactures.

CODE	A	MS	SS	AL	REF	Pcs X 	 X 
------	---	----	----	----	-----	--	---

PD0261P12		80	•			T220188H	1	2
PD0262P14		130	•			T220182H	1	2
PD0263P18		200	•			T220354H	1	2
PD0268P20		260	•			T220439H	1	2

5 DIFFUSORE - SWIRL RING - DIFFUSEUR - DIFFUSOR

PE0260P		30 45	•	•	•	T220180H	1	2
PE0259P		50	•			T220553H	1	2
PE0261P		80 130	•	•	•	T220179H	1	2
PE0262P		200	•	•	•	T220353H	1	2
PE0263P		260	•	•	•	T220436H	1	2

6 ELETTRODO - ELECTRODE - ELECTRODE - ELECTRODO

PR0260P		30	•			T220192H	1	2
PR0259P		50	•			T220552H	1	2
PR0261P		80	•			T220187H	1	2
PR0262P		130	•			T220181H	1	2
PR0263P		200	•			T220352H	1	2
PR0264P		260	•			T220435H	1	2

7 TUBETTO RAFFREDDAMENTO - COOLING TUBE - TUBE DE REFOUDDISSEMENT - TUBO DE REFRIGERACIÓN

FH0809P			•	•	•	T220340H	1	2
---------	---	--	---	---	---	----------	---	---

Tous les noms et marques commerciales, mentionnés ci-dessus, sont la propriété exclusive de leurs respectives sociétés. Trafimet Group n'est pas affilié en aucune façon aux marques des producteurs.

Todos los nombres y marcas comerciales mencionadas son propiedad de sus respectivas compañías. Trafimet Group no está afiliado de ninguna manera con las marcas de los fabricantes.

Soluzione in sacchetto - Plastic bag solution - Sachets en plastiques - Solución en Bolsa

CP 40R - CP 100R

(CP 40R - CP 100R torch)

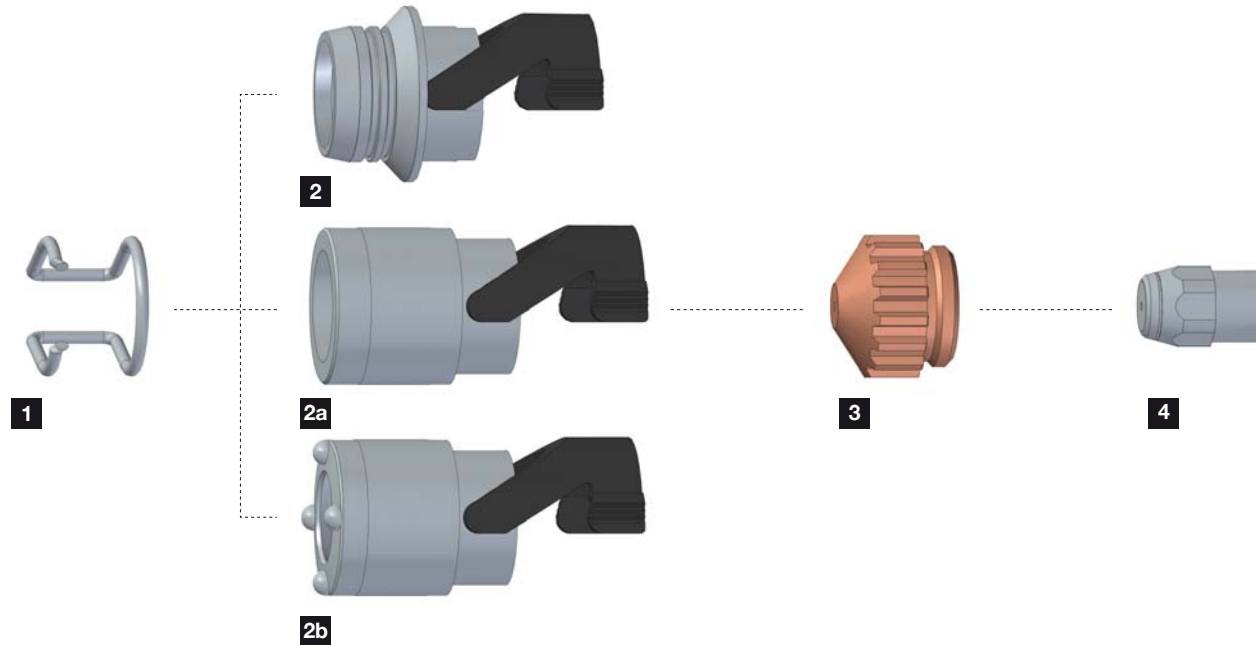

CODE		A	Ø 1,0	Ø 1,2	Ø 1,6	REF	Pcs X 
------	--	---	-------	-------	-------	-----	--

1 DISTANZIALE - STAND OFF GUIDE - PATIN DE TRAÇAGE - SEPARADOR

CV0010						0408-2053	10
--------	---	--	--	--	--	-----------	----

2 SCHERMO STANDARD - STANDARD SHIELD - PATIN STANDARD - ESCUDO ESTÁNDAR

PC0092						0408-2267	1
--------	---	--	--	--	--	-----------	---



2a SCHERMO CERAMICO - CERAMIC SHIELD - PATIN CÉRAMIQUE - ESCUDO CERÁMICO

PC0090						0408-2268	1
--------	---	--	--	--	--	-----------	---



2b SCHERMO A CONTATTO - DRAG SHIELD - PATIN À CONTACTE - ESCUDO A CONTACTO

PC0091						0408-2405	1
--------	---	--	--	--	--	-----------	---

3 CAPPÀ - NOZZLE - TUYÈRE - BOQUILLA

PD0010-10			•			0408-2261	10
PD0010-12				•		0408-2262	10
PD0010-16					•	0408-2385	10

4 ELETTRODO - ELECTRODE - ELECTRODE - ELECTRODO

PR0020						0408-2051	10
PR0021						0408-2404	10

Soluzione in sacchetto - Plastic bag solution - Sachets en plastiques - Solución en Bolsa

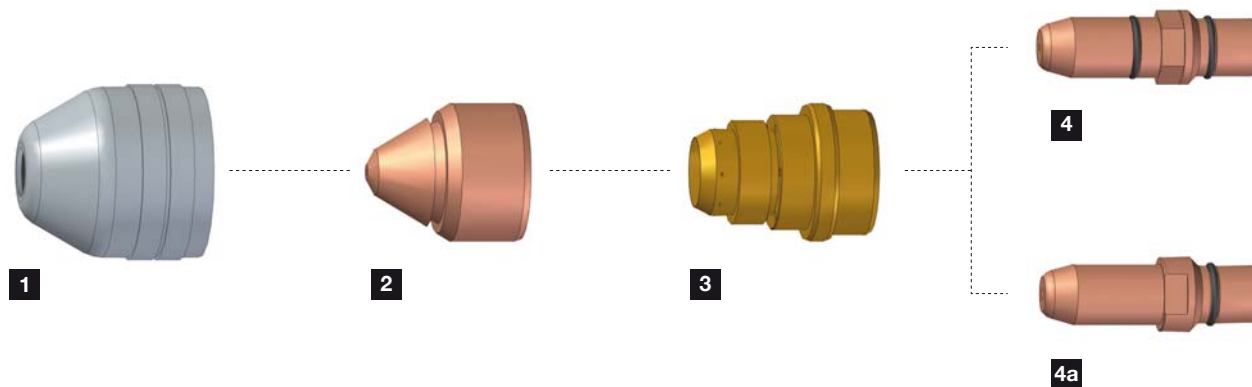



OCP 150 - O₂*(OCP 150 - O₂ torch)*

CODE		A	Ø 0,7	Ø 0,8	Ø 1,0	Ø 1,3	Ø 1,6	REF	Pcs X 
------	--	---	-------	-------	-------	-------	-------	-----	--



1 SCHERMO STANDARD - STANDARD SHIELD - PATIN STANDARD - ESCUDO ESTÁNDAR

PC0040								0409-2166	2
--------	---	--	--	--	--	--	--	-----------	---

2 CAPPÀ - NOZZLE - TUYÈRE - BOQUILLA

PD0086-07		30	•					0409-2173	10
PD0086-08		40		•				0409-2174	10
PD0086-10		60			•			0409-2176	10
PD0086-13		90				•		0409-2183	10
PD0086-16		120					•	0409-2186	10

3 DIFFUSORE - SWIRL RING - DIFFUSEUR - DIFFUSOR

PE0040		60						0409-2170	2
PE0041		120						0409-2169	2

4 ELETTRODO - ELECTRODE - ELECTRODE - ELECTRODO

PR0073								0409-2184	10
--------	---	--	--	--	--	--	--	-----------	----

4a ELETTRODO - ELECTRODE - ELECTRODE - ELECTRODO

PR0075								0409-2185	10
--------	---	--	--	--	--	--	--	-----------	----

Soluzione in sacchetto - Plastic bag solution - Sachets en plastiques - Solución en Bolsa

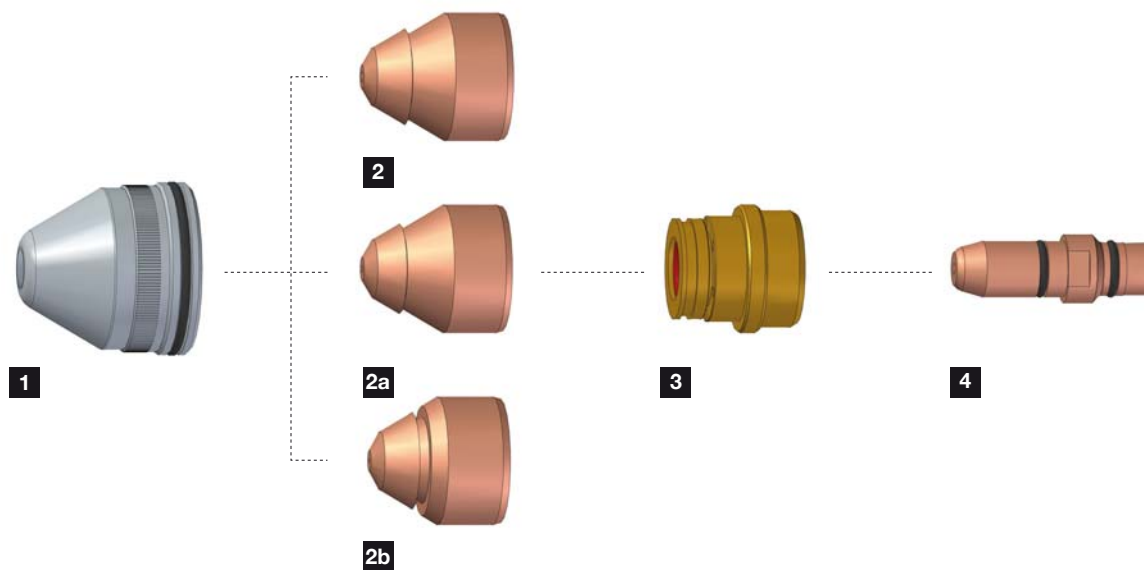

OCP 150 - N₂-Ar/H₂(OCP 150 - N₂-Ar/H₂ torch)

CODE		A	Ø 0,8	Ø 1,0	Ø 1,2	Ø 1,3	Ø 1,6	REF	Pcs X 
------	--	---	-------	-------	-------	-------	-------	-----	--



1 SCHERMO STANDARD - STANDARD SHIELD - PATIN STANDARD - ESCUDO ESTÁNDAR

PC0170								0409-2210	2
--------	---	--	--	--	--	--	--	-----------	---



2 CAPPÀ - NOZZLE - TUYÈRE - BOQUILLA

PD0170-08		40	•					0409-2234	10
PD0170-10		60		•				0409-2236	10

2a CAPPÀ - NOZZLE - TUYÈRE - BOQUILLA

PD0171-13		90			•			0409-2239	10
PD0171-16		120					•	0409-2240	10

2b CAPPÀ - NOZZLE - TUYÈRE - BOQUILLA

PD0172-13		90				•		0409-2249	10
PD0172-16		120					•	0409-2250	10

3 DIFFUSORE - SWIRL RING - DIFFUSEUR - DIFFUSOR

PE0170		60						0409-2209	2
--------	---	----	--	--	--	--	--	-----------	---

4 ELETTRODO - ELECTRODE - ELECTRODE - ELECTRODO

PR0170								0409-2194	10
--------	---	--	--	--	--	--	--	-----------	----

Soluzione in sacchetto - Plastic bag solution - Sachets en plastiques - Solución en Bolsa

D - 8000

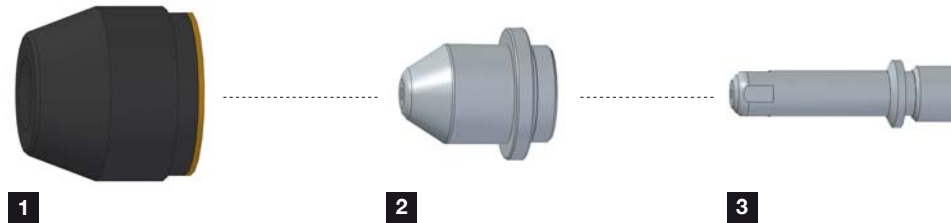
(D - 8000 torch)

CODE		A	Ø 1,3	REF	Pcs X 
------	--	---	-------	-----	--

1 SCHERMO STANDARD - STANDARD SHIELD - PATIN STANDARD - ESCUDO ESTÁNDAR

PC0308				H767J00	2
--------	---	--	--	---------	---

2 CAPPÀ - NOZZLE - TUYÈRE - BOQUILLA

PD0310-13		80		H767F01	10
-----------	---	----	---	---------	----

3 ELETTRODO - ELECTRODE - ELECTRODE - ELECTRODO

PR0309				H839M00	10
--------	---	--	--	---------	----

Soluzione in sacchetto - Plastic bag solution - Sachets en plastiques - Solución en Bolsa

D - 12000

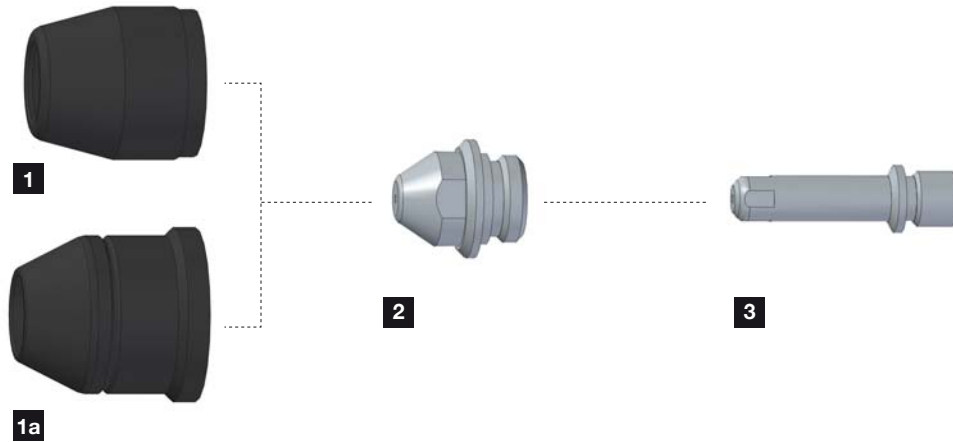
(D - 12000 torch)

CODE		A	Ø 0,8	Ø 1,0	Ø 1,3	Ø 1,6	REF	Pcs X 
------	--	---	-------	-------	-------	-------	-----	--





1 SCHERMO STANDARD - STANDARD SHIELD - PATIN STANDARD - ESCUDO ESTÁNDAR

PC0309							H839G02	2
--------	---	--	--	--	--	--	---------	---

1a SCHERMO CERAMICO - CERAMIC SHIELD - PATIN CÉRAMIQUE - ESCUDO CERÁMICO

PC0311							W0300167	2
--------	---	--	--	--	--	--	----------	---

2 CAPPÀ - NOZZLE - TUYÈRE - BOQUILLA

PD0309-08		30	•				H839K03	10
PD0309-10		50		•			H839K02	10
PD0309-13		80			•		H839K01	10
PD0309-16		120				•	H839G03	10

3 ELETTRODO - ELECTRODE - ELECTRODE - ELECTRODO

PR0309							H839M00	10
--------	---	--	--	--	--	--	---------	----

Soluzione in sacchetto - Plastic bag solution - Sachets en plastiques - Solución en Bolsa

Dynapak 110® (PCH 20)

PAK 2XT® (PCH 20)

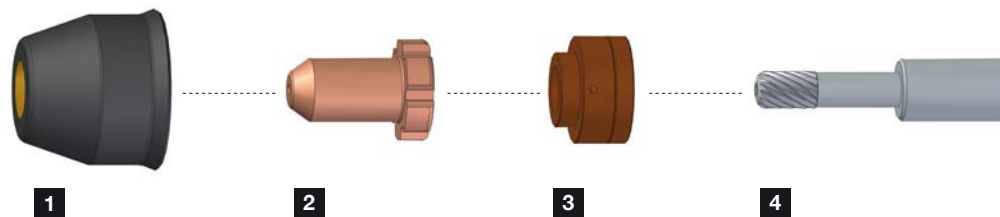

CODE		A	Ø 0,7	REF	Pcs X 
------	--	---	-------	-----	--

1 SCHERMO STANDARD - STANDARD SHIELD - PATIN STANDARD - ESCUDO ESTÁNDAR

PC0070				8-3214	2
--------	---	--	--	--------	---

2 CAPPÀ - NOZZLE - TUYÈRE - BOQUILLA

PD0501-07		20		8-3218	10
-----------	---	----	---	--------	----

3 DIFFUSORE - SWIRL RING - DIFFUSEUR - DIFFUSOR

PE0030				8-3233	2
--------	---	--	--	--------	---

4 ELETTRODO - ELECTRODE - ELECTRODE - ELECTRODO

PR0080				9-6006	10
--------	---	--	--	--------	----

Soluzione in sacchetto - Plastic bag solution - Sachets en plastiques - Solución en Bolsa

PakMaster® 25 (PCH 25)

EconoPak® 25 (PCH 25)

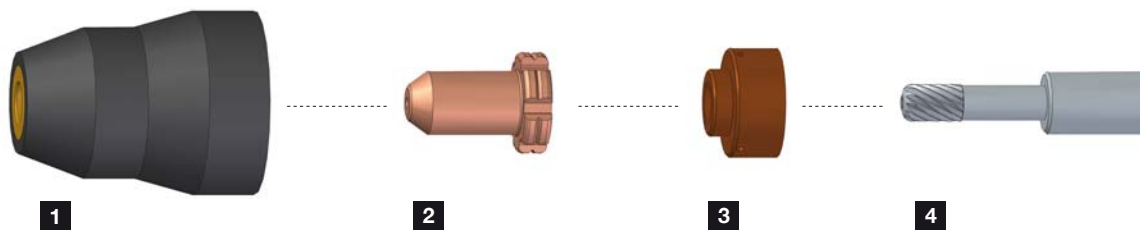

CODE		A	Ø 0,7	REF	Pcs X 
------	--	---	-------	-----	--

1 SCHERMO STANDARD - STANDARD SHIELD - PATIN STANDARD - ESCUDO ESTÁNDAR

PC0071				9-6003	2
--------	---	--	--	--------	---

2 CAPPÀ - NOZZLE - TUYÈRE - BOQUILLA

PD0502-07		20	•	9-4476	10
-----------	---	----	---	--------	----

3 DIFFUSORE - SWIRL RING - DIFFUSEUR - DIFFUSOR

PE0031				9-6007	2
--------	---	--	--	--------	---

4 ELETTRODO - ELECTRODE - ELECTRODE - ELECTRODO

PR0080				9-6006	10
--------	---	--	--	--------	----

Soluzione in sacchetto - Plastic bag solution - Sachets en plastiques - Solución en Bolsa

Stak Pak® 35 (PCH/M-35)

PakMaster® 50 (PCH/M-35)

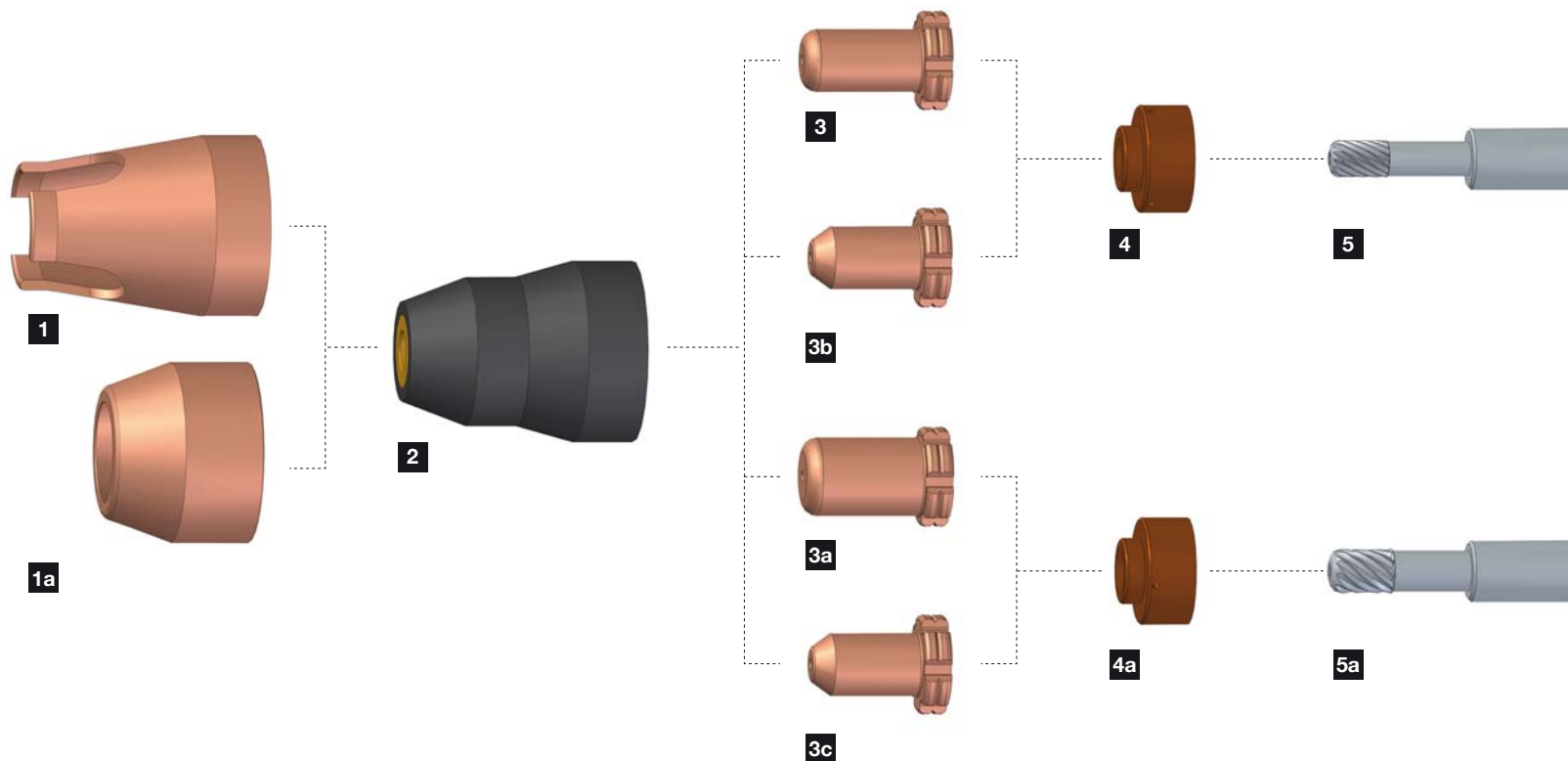

CODE	A	Ø 0,8	REF	Pcs X 
------	---	-------	-----	--

1 DISTANZIALE - STAND OFF GUIDE - PATIN DE TRAÇAGE - SEPARADOR

PC0072			9-6004	2
--------	---	--	--------	---

1a COPRI SCHERMO LUNGA DURATA - LONG LIFE CUP - PROTECTION LONGUE DURÉ - ESCUDO DE COBERTURA DE LARGA DURACIÓN

PC0073			9-6503	2
--------	---	--	--------	---

2 SCHERMO STANDARD - STANDARD SHIELD - PATIN STANDARD - ESCUDO ESTÁNDAR

PC0071			9-6003	2
--------	---	--	--------	---

3 CAPP A - NOZZLE - TUYÈRE - BOQUILLA

PD0503-08		35		9-6000	10
-----------	---	----	---	--------	----

3a CAPP A LUNGA DURATA - LONG LIFE NOZZLE - TUYÈRE LONGUE DURÉ - BOQUILLA DE LARGA DURACIÓN

PD0507-08		35		9-6500	10
-----------	---	----	---	--------	----

3b CAPP A TAGLIO VELOCE - FAST CUT NOZZLE - TUYÈRE COUPE RAPIDE - BOQUILLA DE CORTE RAPIDO

PD0505-08		35		9-6001	10
-----------	---	----	---	--------	----

3c CAPP A TAGLIO VELOCE - FAST CUT NOZZLE - TUYÈRE COUPE RAPIDE - BOQUILLA DE CORTE RAPIDO

PD0506-08		35		9-6501	10
-----------	---	----	---	--------	----

4 DIFFUSORE - SWIRL RING - DIFFUSEUR - DIFFUSOR

PE0031			9-6007	2
--------	---	--	--------	---

CODE	A	Ø 0,8	REF	Pcs X 
------	---	-------	-----	--

4a DIFFUSORE LUNGA DURATA - LONG LIFE SWIRL RING - DIFFUSEUR LONGUE DURÉ - DIFUSOR DE LARGA DURACIÓN

PE0032			9-6507	2
--------	---	--	--------	---

5 ELETTRODO - ELECTRODE - ELECTRODE - ELECTRODO

PR0080			9-6006	10
--------	---	--	--------	----

5a ELETTRODO LUNGA DURATA - LONG LIFE ELECTRODE - ÉLECTRODE LONGUE DURÉ - ELECTRODO DE LARGA DURACIÓN

PR0081			9-6506	10
--------	---	--	--------	----

Soluzione in sacchetto - Plastic bag solution - Sachets en plastiques - Solución en Bolsa

PAX® 3XR-5XR-5XT-6XR-625XR-750XR (PCH/M-51)

Dynapak® 4xi - 6xi (PCH/M-51)

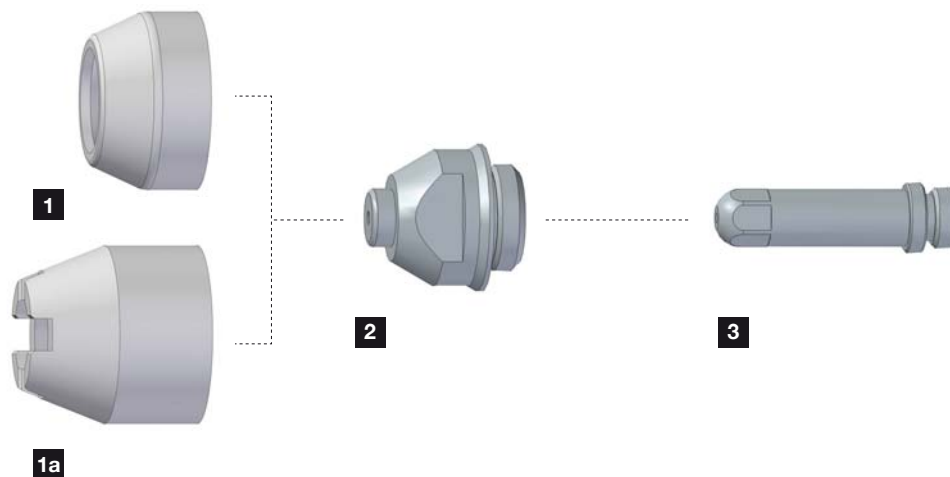

CODE		A	Ø 0,9	Ø 1,1	Ø 1,2	REF	Pcs X 
------	--	---	-------	-------	-------	-----	--



1 SCHERMO STANDARD - STANDARD SHIELD - PATIN STANDARD - ESCUDO ESTÁNDAR

PC0050		30 60				9-5630	5
--------	---	----------	--	--	--	--------	---

1a SCHERMO A CONTATTO - DRAG SHIELD - PATIN À CONTACTE - ESCUDO A CONTACTO

PC0051		30 60				8-5526	10
--------	---	----------	--	--	--	--------	----

2 CAPPA - NOZZLE - TUYÈRE - BOQUILLA

PD0012-09		10 40	•			9-5718	10
PD0012-11		10 60		•		9-5631	10
PD0012-12		10 70			•	8-3321	10

3 ELETTRODO - ELECTRODE - ELECTRODE - ELECTRODO

PR0025						9-5633	10
--------	---	--	--	--	--	--------	----

Soluzione in sacchetto - Plastic bag solution - Sachets en plastiques - Solución en Bolsa

PAX® 5XR-6XR-7XR-8XR-10XR-625XR-750XR-1000XR-1250XR (PCH/M-52)

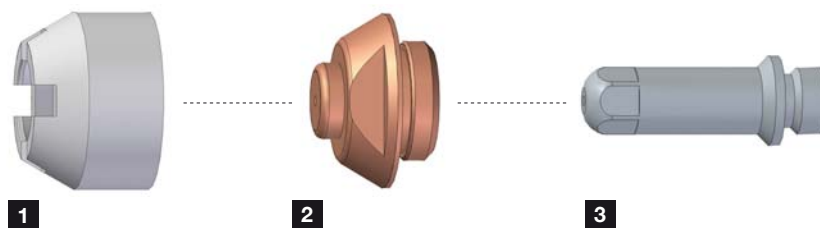



CODE		A	Ø 1,1	Ø 1,2	Ø 1,5	REF	Pcs X 
------	--	---	-------	-------	-------	-----	--

1 SCHERMO A CONTATTO - DRAG SHIELD - PATIN À CONTACTE - ESCUDO A CONTACTO

PC0053						9-5694	10
--------	---	--	--	--	--	--------	----

2 CAPPA - NOZZLE - TUYÈRE - BOQUILLA

PD0021-11		40 55	•			9-5618	10
PD0021-12		60 70		•		9-5707	10
PD0021-15		105			•	9-5708	10

3 ELETTRODO - ELECTRODE - ELECTRODE - ELECTRODO

PR0024						9-5619	10
--------	---	--	--	--	--	--------	----

Soluzione in sacchetto - Plastic bag solution - Sachets en plastiques - Solución en Bolsa

PakMaster® 75XL Plus (PCH/M-60)

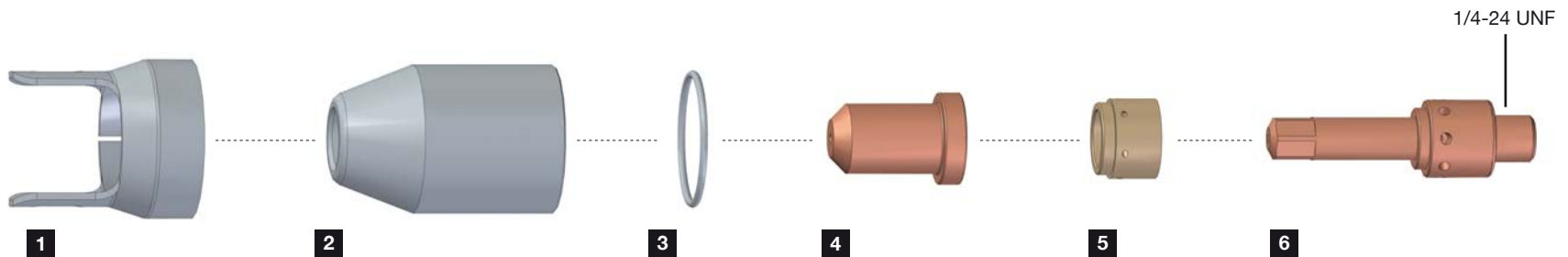

CODE		A	Ø 1,0	Ø 1,2	REF	Pcs X 
------	--	---	-------	-------	-----	--

1 DISTANZIALE - STAND OFF GUIDE - PATIN DE TRAÇAGE - SEPARADOR

CV0102					8-7575	2
--------	---	--	--	--	--------	---



2 SCHERMO STANDARD - STANDARD SHIELD - PATIN STANDARD - ESCUDO ESTÁNDAR

PC0082					8-7500	2
--------	---	--	--	--	--------	---

3 MOLLA - SPRING - RESSORT - MUELLE

CV0101					9-7501	10
--------	---	--	--	--	--------	----

4 CAPPА - NOZZLE - TUYÈRE - BOQUILLA

PD0091-10		35	•		8-7503	10
PD0091-12		60		•	9-7726	10

5 DIFFUSORE - SWIRL RING - DIFFUSEUR - DIFFUSOR

PE0034					8-7501	2
--------	---	--	--	--	--------	---

6 ELETTRODO - ELECTRODE - ELECTRODE - ELECTRODO

PR0086					8-7502	10
--------	---	--	--	--	--------	----

Soluzione in sacchetto - Plastic bag solution - Sachets en plastiques - Solución en Bolsa

STAK PAK®

(PCH/M-70)

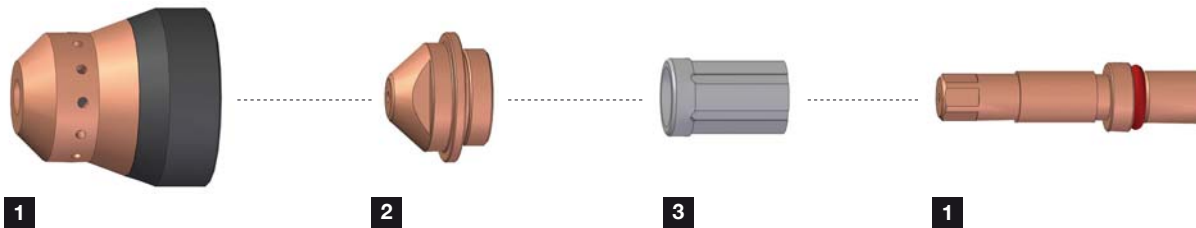

CODE		A	Ø 1,2	REF	Pcs X 
------	--	---	-------	-----	--

1 SCHERMO STANDARD - STANDARD SHIELD - PATIN STANDARD - ESCUDO ESTÁNDAR

PC0076				9-6016	2
--------	---	--	--	--------	---

2 CAPPA - NOZZLE - TUYÈRE - BOQUILLA

PD0508-12		70	•	9-6009	10
-----------	---	----	---	--------	----

3 DIFFUSORE - SWIRL RING - DIFFUSEUR - DIFFUSOR

PE0033				9-6022	2
--------	---	--	--	--------	---

4 ELETTRODO - ELECTRODE - ELECTRODE - ELECTRODO

PR0008				9-6019	10
--------	---	--	--	--------	----

Soluzione in sacchetto - Plastic bag solution - Sachets en plastiques - Solución en Bolsa

PakMaster® 75-75XL-100XL Plus (PCH/M-75)

EconoPak® 100 (PCH/M-75)

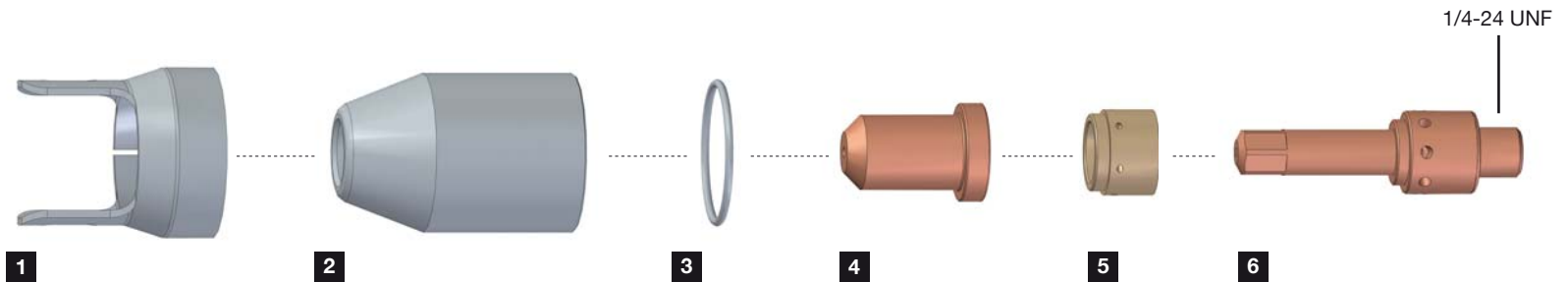

CODE		A	Ø 1,0	Ø 1,2	REF	Pcs X 
------	--	---	-------	-------	-----	--

1 DISTANZIALE - STAND OFF GUIDE - PATIN DE TRAÇAGE - SEPARADOR

CV0102					8-7575	2
--------	---	--	--	--	--------	---



2 SCHERMO STANDARD - STANDARD SHIELD - PATIN STANDARD - ESCUDO ESTÁNDAR

PC0082					8-7500	2
--------	---	--	--	--	--------	---

3 MOLLA - SPRING - RESSORT - MUELLE

CV0101					9-7501	10
--------	---	--	--	--	--------	----

4 CAPPА - NOZZLE - TUYÈRE - BOQUILLA

PD0091-10		35	•		8-7503	10
PD0091-12		55		•	8-7504	10

5 DIFFUSORE - SWIRL RING - DIFFUSEUR - DIFFUSOR

PE0034					8-7501	2
--------	---	--	--	--	--------	---

6 ELETTRODO - ELECTRODE - ELECTRODE - ELECTRODO

PR0086					8-7502	10
--------	---	--	--	--	--------	----

Soluzione in sacchetto - Plastic bag solution - Sachets en plastiques - Solución en Bolsa

EconoPak® 100

(PCH/M-76)

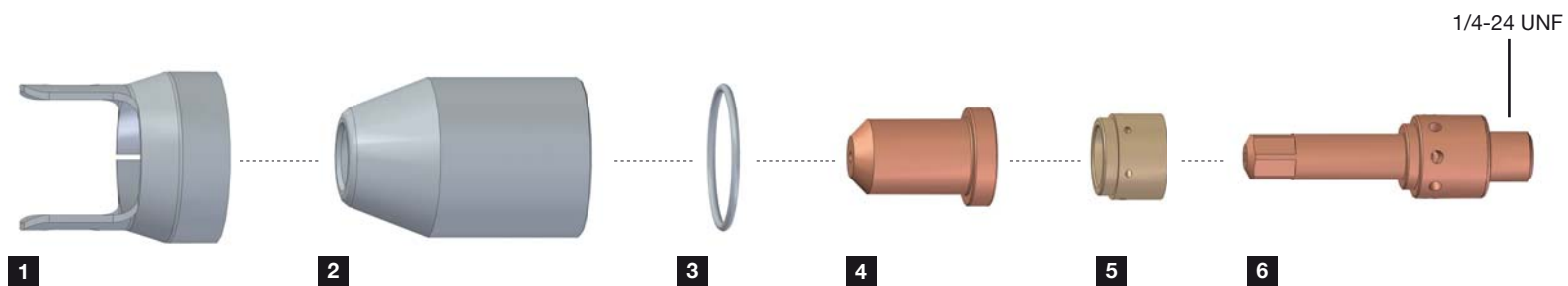

CODE		A	Ø 1,0	Ø 1,2	REF	Pcs X 
------	--	---	-------	-------	-----	--

1 DISTANZIALE - STAND OFF GUIDE - PATIN DE TRAÇAGE - SEPARADOR

CV0102					8-7575	2
--------	---	--	--	--	--------	---



2 SCHERMO STANDARD - STANDARD SHIELD - PATIN STANDARD - ESCUDO ESTÁNDAR

PC0082					8-7500	2
--------	---	--	--	--	--------	---

3 MOLLA - SPRING - RESSORT - MUELLE

CV0101					9-7501	10
--------	---	--	--	--	--------	----

4 CAPPА - NOZZLE - TUYÈRE - BOQUILLA

PD0091-10		35	•		8-7503	10
PD0092-13		70		•	8-7505	10

5 DIFFUSORE - SWIRL RING - DIFFUSEUR - DIFFUSOR

PE0034					8-7501	2
--------	---	--	--	--	--------	---

6 ELETTRODO - ELECTRODE - ELECTRODE - ELECTRODO

PR0086					8-7502	10
--------	---	--	--	--	--------	----

Soluzione in sacchetto - Plastic bag solution - Sachets en plastiques - Solución en Bolsa

PakMaster® 100XL Plus (PCH/M-80)

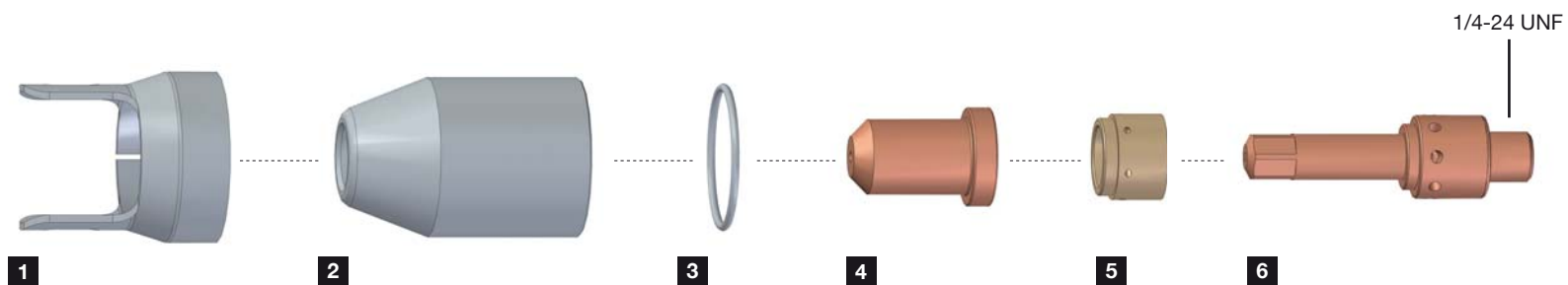

CODE		A	Ø 1,0	Ø 1,2	Ø 1,4	REF	Pcs X 
------	--	---	-------	-------	-------	-----	--

1 DISTANZIALE - STAND OFF GUIDE - PATIN DE TRAÇAGE - SEPARADOR

CV0102						8-7575	2
--------	---	--	--	--	--	--------	---



2 SCHERMO STANDARD - STANDARD SHIELD - PATIN STANDARD - ESCUDO ESTÁNDAR

PC0082						8-7500	2
--------	---	--	--	--	--	--------	---

3 MOLLA - SPRING - RESSORT - MUELLE

CV0101						9-7501	10
--------	---	--	--	--	--	--------	----

4 CAPPА - NOZZLE - TUYÈRE - BOQUILLA

PD0091-10		35	•			8-7503	10
PD0091-12		55		•		8-7504	10
PD0093-14		80			•	9-7728	10

5 DIFFUSORE - SWIRL RING - DIFFUSEUR - DIFFUSOR

PE0034						8-7501	2
--------	---	--	--	--	--	--------	---

6 ELETTRODO - ELECTRODE - ELECTRODE - ELECTRODO

PR0086						8-7502	10
--------	---	--	--	--	--	--------	----

Soluzione in sacchetto - Plastic bag solution - Sachets en plastiques - Solución en Bolsa

PAK®10XR

(PCH/M-100)





CODE		A	Ø 1,0	Ø 1,3	Ø 1,5	REF	Pcs X 
------	--	---	-------	-------	-------	-----	--

1 SCHERMO STANDARD - STANDARD SHIELD - PATIN STANDARD - ESCUDO ESTÁNDAR

PC0055						8-1100	10
--------	---	--	--	--	--	--------	----

2 CAPPA - NOZZLE - TUYÈRE - BOQUILLA

PD0017-10		35	•			9-4343	10
PD0017-13		70		•		9-4342	10
PD0017-15		105			•	9-4341	10

3 Elettrodo - Electrode - Electrode - Electrodo

PR0029						9-4340	10
--------	---	--	--	--	--	--------	----

Soluzione in sacchetto - Plastic bag solution - Sachets en plastiques - Solución en Bolsa

PT 40

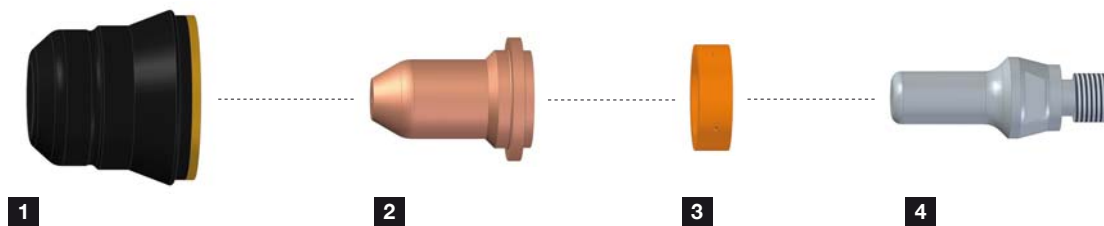



CODE		A	Ø 0,8	Ø 0,9	REF	Pcs X 
------	--	---	-------	-------	-----	--

1 SCHERMO STANDARD - STANDARD SHIELD - PATIN STANDARD - ESCUDO ESTÁNDAR

PC0116					60389	4
--------	---	--	--	--	-------	---

2 CAPPА - NOZZLE - TUYÈRE - BOQUILLA

PD0350-08		30	•		51318.08	10
PD0350-09		40		•	51318.09	10

3 DIFFUSORE - SWIRL RING - DIFFUSEUR - DIFFUSOR

PE0106					60028	2
--------	---	--	--	--	-------	---

4 ELETTRODO - ELECTRODE - ELECTRODE - ELECTRODO

PR0352					52582	10
--------	---	--	--	--	-------	----



Tutti i nomi e marchi sopra citati sono di esclusiva proprietà delle rispettive aziende. Trafimet Group non è affiliata in alcun modo ai marchi citati dei produttori.

All the above names and trademarks are of exclusive property of the respective companies. Trafimet Group is not way affiliated with the above-named manufactures.

Tous les noms et marques commerciales, mentionnées ci-dessus, sont la propriété exclusive de leurs respectives sociétés. Trafimet Group n'est pas affilié en aucune façon aux marques des producteurs.

Todos los nombres y marcas comerciales mencionadas son propiedad de sus respectivas compañías. Trafimet Group no está afiliado de ninguna manera con las marcas de los fabricantes.

Soluzione in sacchetto - Plastic bag solution - Sachets en plastiques - Solución en Bolsa

PT 60

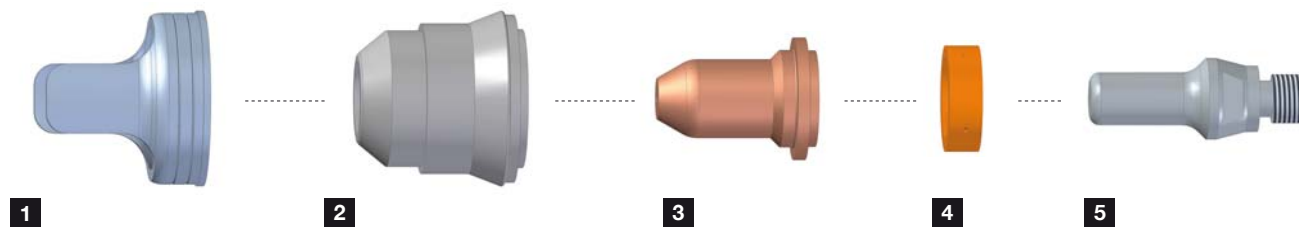

CODE		A	Ø 0,8	Ø 0,9	REF	Pcs X 
------	--	---	-------	-------	-----	--



1 DISTANZIALE - STAND OFF GUIDE - PATIN DE TRAÇAGE - SEPARADOR

CV0315					60432	2
--------	---	--	--	--	-------	---

2 SCHERMO STANDARD - STANDARD SHIELD - PATIN STANDARD - ESCUDO ESTÁNDAR

PC0348					60389	1
--------	---	--	--	--	-------	---

3 CAPPÀ - NOZZLE - TUYÈRE - BOQUILLA

PD0350-08		30	•		51318.08	10
PD0350-09		40		•	51318.09	10

4 DIFFUSORE - SWIRL RING - DIFFUSEUR - DIFFUSOR

PE0106					60028	2
--------	---	--	--	--	-------	---

5 ELETTRODO - ELECTRODE - ELECTRODE - ELECTRODO

PR0352					52582	10
--------	---	--	--	--	-------	----



Soluzione in sacchetto - Plastic bag solution - Sachets en plastiques - Solución en Bolsa

PT 80

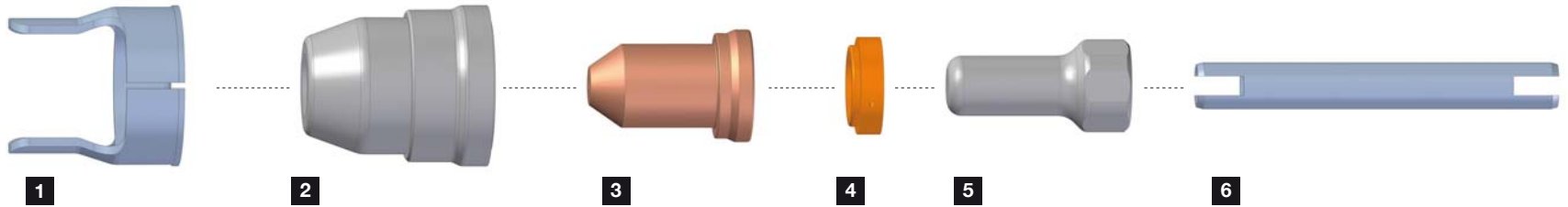

CODE	A	Ø 1,0	Ø 1,1	Ø 1,2	Ø 1,3	REF	Pcs X 
------	---	-------	-------	-------	-------	-----	--





1 DISTANZIALE - STAND OFF GUIDE - PATIN DE TRAÇAGE - SEPARADOR

CV0314						60434	2
--------	---	--	--	--	--	-------	---

2 SCHERMO STANDARD - STANDARD SHIELD - PATIN STANDARD - ESCUDO ESTÁNDAR

PC0347						60510	1
--------	---	--	--	--	--	-------	---

3 CAPPÀ - NOZZLE - TUYÈRE - BOQUILLA

PD0345-10		40 50	•			51311.10	10	
PD0345-11		50 60		•		51311.11	10	
PD0345-12		60 70			•	51311.12	10	
PD0345-13		70 80				•	51311.13	10



Tutti i nomi e marchi sopra citati sono di esclusiva proprietà delle rispettive aziende. Trafimet Group non è affiliata in alcun modo ai marchi citati dei produttori.

All the above names and trademarks are of exclusive property of the respective companies. Trafimet Group is not way affiliated with the above-named manufactures.

CODE	A	Ø 1,0	Ø 1,1	Ø 1,2	Ø 1,3	REF	Pcs X
------	---	-------	-------	-------	-------	-----	-------

4 DIFFUSORE - SWIRL RING - DIFFUSEUR - DIFFUSOR

PE0132						60027	2
--------	---	--	--	--	--	-------	---

5 ELETTRODO - ELECTRODE - ELECTRODE - ELECTRODO

PR0351						52558	10
--------	---	--	--	--	--	-------	----

6 TUBETTO RAFFREDDAMENTO - COOLING TUBE - TUBE DE REFROIDISSEMENT - TUBO DE REFRIGERACIÓN

FH0931						09800.42	2
--------	---	--	--	--	--	----------	---

Tous les noms et marques commerciales, mentionnés ci-dessus, sont la propriété exclusive de leurs respectives sociétés. Trafimet Group n'est pas affilié en aucune façon aux marques des producteurs.

Todos los nombres y marcas comerciales mencionadas son propiedad de sus respectivas compañías. Trafimet Group no está afiliado de ninguna manera con las marcas de los fabricantes.

Soluzione in sacchetto - Plastic bag solution - Sachets en plastiques - Solución en Bolsa

PT 100

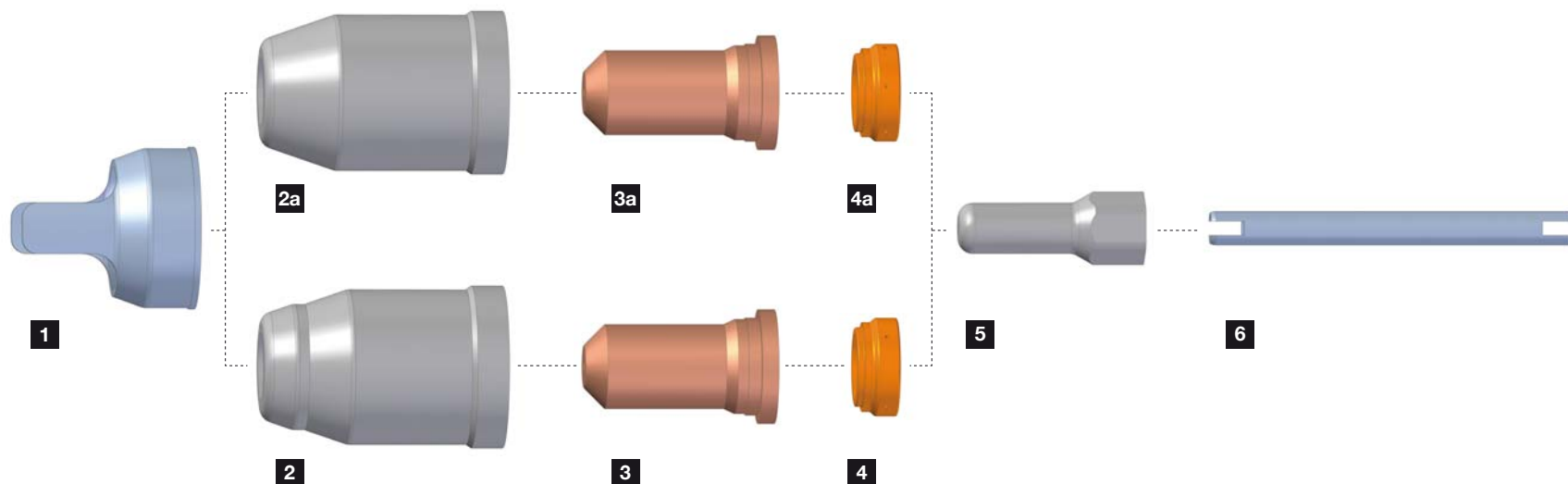

CODE	A	Ø 1,2	Ø 1,4	Ø 1,5	Ø 1,6	REF	Pcs X 
------	---	-------	-------	-------	-------	-----	--

1 DISTANZIALE - STAND OFF GUIDE - PATIN DE TRAÇAGE - SEPARADOR

CV0313						60444	2
--------	---	--	--	--	--	-------	---



2 SCHERMO STANDARD - STANDARD SHIELD - PATIN STANDARD - ESCUDO ESTÁNDAR

PC0345		30 70				60500	1
--------	---	----------	--	--	--	-------	---

2a SCHERMO STANDARD - STANDARD SHIELD - PATIN STANDARD - ESCUDO ESTÁNDAR

PC0346		80 120				60501	1
--------	---	-----------	--	--	--	-------	---

3 CAPPA - NOZZLE - TUYÈRE - BOQUILLA

PD0338-10		40 50	•			51246.10	10
PD0338-11		50 60	•			51246.11	10
PD0338-12		60 70	•			51246.12	10





Tutti i nomi e marchi sopra citati sono di esclusiva proprietà delle rispettive aziende. Trafimet Group non è affiliata in alcun modo ai marchi citati dei produttori.

All the above names and trademarks are of exclusive property of the respective companies. Trafimet Group is not way affiliated with the above-named manufactures.

CODE	A	Ø 1,2	Ø 1,4	Ø 1,5	Ø 1,6	REF	Pcs X
------	---	-------	-------	-------	-------	-----	-------

3a CAPPA - NOZZLE - TUYÈRE - BOQUILLA

PD0340-14		80 90	•			51248.14	10
PD0340-15		100 110		•		51248.15	10
PD0340-16		110 120			•	51248.16	10

4 DIFFUSORE - SWIRL RING - DIFFUSEUR - DIFFUSOR

PE0130		30 70				60025	2
--------	---	----------	--	--	--	-------	---

4a DIFFUSORE - SWIRL RING - DIFFUSEUR - DIFFUSOR

PE0131		80 120				60026	2
--------	---	-----------	--	--	--	-------	---

5 ELETTRODO - ELECTRODE - ELECTRODE - ELECTRODO

PR0350						52556	10
--------	---	--	--	--	--	-------	----

6 TUBETTO RAFFREDDAMENTO - COOLING TUBE - TUBE DE REFOUÏSSEMENT - TUBO DE REFRIGERACIÓN

FH0930						09700.48	2
--------	---	--	--	--	--	----------	---

Tous les noms et marques commerciales, mentionnées ci-dessus, sont la propriété exclusive de leurs respectives sociétés. Trafimet Group n'est pas affilié en aucune façon aux marques des producteurs.

Todos los nombres y marcas comerciales mencionadas son propiedad de sus respectivas compañías. Trafimet Group no está afiliado de ninguna manera con las marcas de los fabricantes.

Soluzione in blister - Blister's solution - Solution en blisters - Solución en blister

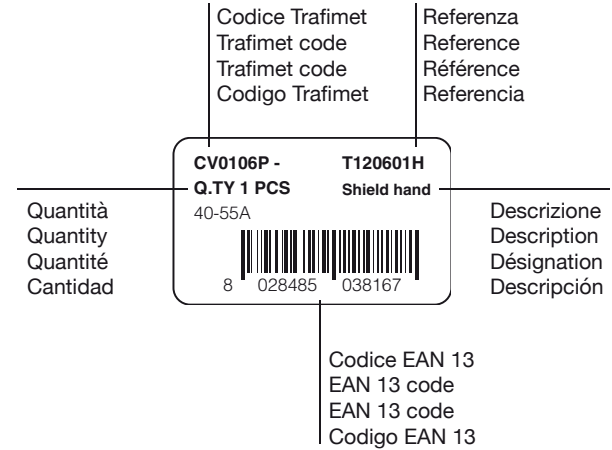

Alcuni articoli potrebbero essere forniti singolarmente in contenitore plastico

Some items may be provided individually on a plastic box

Certains éléments pourraient être fournis individuellement dans une boîte en plastique

Algunos elementos pueden proporcionarse de forma individual en caja de plástico

Soluzione in sacchetto - Plastic bag solution - Sachets en plastiques - Solución en Bolsa



Espositore TrafimetPro da parete - TrafimetPro wall module package - Présentoir Trafimet Pro à mur - Expositor Trafimet Pro de pared

Codice - Code Code - Código	EA1200
Dimensioni - Size Dimensions - Tamaño	1030 x 560 x 2265
Contiene - Contains - Contiens - Incluye	
Parete da muro - Wall pannel Paneaux à mur - Panel de pared	1 Pcs.
Supporti laterali - Side pannels Supports latéraux - Soportes laterales	2 Pcs.
Basamento - Bottom shelf Base - Base	1 Pcs.
Ripiano - Shelf Etagère - Estante	1 Pcs.
Logo superiore - Upper logo Logo supérieure - Logo superior	1 Pcs.
Ganci - Hangers Crochet - Anzuelos	35Pcs.



Diffusore - Swirl ring Diffuseur - Diffusor	2 Blisters
Elettrodo - Electrode Electrode - Electrodo	2 Blisters
Cappa - Nozzle Tuyère - Boquilla	2 Blisters
Ugello porta schermo - Retaining cap Buse protection - Tobera de retención	2 Blisters
Schermo - Shield Patin - Escudo	2 Blisters

Condizioni generali di vendita

Art. 1 - Validità e diritto di modifica

Tutti i contratti stipulati con il cliente saranno soggetti a queste condizioni di vendita che soprassedono qualsiasi termine e condizione di vendita precedente. Il venditore si riserva il diritto di aggiungere, modificare o variare le condizioni qui elencate tramite conferma scritta al cliente.

Art. 2 - Conferma degli ordini

Gli ordini che pervengono in sede sia direttamente che tramite agente, mentre impegnano il Cliente committente, sono in ogni caso subordinati all'approvazione definitiva della sede che ha la facoltà di rifiutarli entro 15 giorni da ricevimento.

Eventuali modifiche verbali da apportare agli ordini, dovranno essere confermate per iscritto dal Cliente altrimenti ci solleviamo da qualsiasi responsabilità per errori o incomprensioni.

Art. 3 - Revisione prezzi

Per ogni eventuale variazione dei costi delle materie prime e della manodopera durante il corso della fornitura, sia ufficialmente autorizzate che dovute ad altre cause dipendenti da contingenti condizioni locali, verrà riservato il diritto di revisione dei prezzi previo motivato avviso.

Art. 4 - Spedizioni

La merce venduta per consegna in qualsiasi località stabilita in contratto e con qualsiasi mezzo di trasporto viaggia a rischio e pericolo del committente.

Art. 5 - Interessi e spese

In caso di ritardo di pagamento, verranno addebitati gli interessi di mora in ragione del tasso previsto dalla nuova normativa in materia (D.L. n. 192/2012), oltre alle spese di incasso, diritti bancari e spese legali.

Art. 6 - Luogo del pagamento ed essenzialità delle scadenze

Il pagamento dovrà effettuarsi esclusivamente alla sede di Castegnaro (VI).

L'accettazione di effetti o di portafoglio o la emissione di tratte, anche se convenuto per condizioni di contratto, importa né deroga, né novazione al luogo di pagamento in Castegnaro (VI).

Art. 7 - Proprietà della merce

Resta inteso che fino all'avvenuto pagamento per intero della merce consegnata, la merce fornita o giacente presso i locali del cliente resta di nostra proprietà. Ci riserviamo il diritto in qualsiasi momento di revocare al

compratore il diritto di disposizione con comunicazione scritta al compratore, nel caso in cui lo stesso fosse in difetto per qualsiasi somma dovuta per più di sette giorni lavorativi.

Art. 8 - Sospensione delle forniture

Se il cliente non effettua il pagamento nei termini prestabiliti dal venditore oppure è insolvente o sottoposto a procedura fallimentare o è in liquidazione, il venditore può sospendere a sua discrezione, ogni fornitura.

Art. 9 - Vizi della merce

I difetti derivanti dalle materie prime o dalla lavorazione e ogni altro difetto e vizio del prodotto, fatte salve le tolleranze d'uso, daranno luogo a nient'altro che la semplice sostituzione dei pezzi riconosciuti difettosi dal nostro ufficio Controllo Qualità o, a nostra discrezione, ad emissione di relativa nota d'accredito con esclusione di qualunque ulteriore risarcimento danni. Saranno presi in considerazione soltanto i reclami che perverranno alla sede di Castegnaro entro 7 giorni dalla data di consegna della merce. Il reso della merce dovrà essere concordato preventivamente nelle sue modalità comprese eventuali spese di trasporto. Qualsiasi reso di merce non autorizzato darà luogo ad un immediato reinoltro al mittente a spese di quest'ultimo.

Art. 10 - Resi di materiale

Non verranno accettati resi di materiali di ritorno senza la preventiva autorizzazione della nostra sede. Il reso dovrà riferirsi unicamente a prodotti nuovi ed inutilizzati, di corrente produzione. Sarà operato un addebito per spese di ristoccaggio non inferiore al 15% del valore di acquisto della merce.

Art. 11 - Consegne

Eventuali ritardi non possono dar luogo a pretese di danni né a risoluzione anche parziale di contratto.

Art. 12 - Giurisdizione e legge applicabile

Anche in deroga a qualunque patto contrario, in caso di controversia il Foro competente è esclusivamente quello di Vicenza (art. 28 Cod. Proc.Civ.) e la legge applicabile è quella italiana.

Sarà comunque facoltà del venditore agire anche in fori diversi, ove convenuto dalle leggi.

Art. 13 Validità

Le preferenti condizioni di vendita annullano e sostituiscono ogni altra condizione di vendita eventualmente riportata sui nostri documenti, se differenti.

General terms of sale

Art. 1 - Validity and right of variation

All the contracts made by the Seller shall be subjected to these terms and conditions of sale which supersede any earlier terms and conditions of sale. The Seller does hereby reserve the right to add, to amend or vary the conditions as herein set out, by including such additions, variations or amendments to the quotation or in any written correspondence addressed to the Buyer.

Art. 2 - Order confirmation

Orders' acceptance and Seller's disclaimers of liability for any information held by the Seller shall have the right to refuse any order within fifteen days from receipt. Verbal or telephone orders and any amendments to orders must be confirmed in writing by the Buyer, otherwise the Seller will not accept responsibility for mistakes or consequent misunderstandings.

Art. 3 - Price changes

The Seller shall have the right to increase prices, with prior notice, in accordance with any change of the raw materials and labor costs which may take place between the date of order and the delivery.

Art. 4 - Transportation

The goods, sent to any place fixed by the contract and with any kind of carrier has to transit at own risk and cost of the buyer.

Art. 5 - Interests and charges

In case of delayed payment, the Seller shall charge default interest charges in right of the legal rate subject of the new body of legislation (D.L. N. 192/2012), besides cashing charges, bank rights and legal expenses.

Art. 6 - Payments and expiry

Payments must be made only to the head office in Castegnaro (VI, Italy). Bills' acceptance or issue of drafts, even if these are stated on the contract, do not involve either departure or novation of payment's place located in Castegnaro (VI, Italy).

Art. 7 - Retention of title

Until the full payment has been received by the Seller for all products to be supplied, all goods remain property of the Seller. The Seller shall have the right at any time to revoke the Buyer's right of disposition by written notice to the Buyer, in case the Buyer is in default for any sum due to the Seller for more than seven working days.

Art. 8 - Suspension of deliveries

If the Buyer fails to make payment in due time according terms stated by the Seller or he becomes insolvent or has a receiver appointed or passes a resolution for winding up, the Seller may suspend, at its option, every delivery.

Art. 9 - Defective goods

Any kind of defect of the goods, due to faulty raw materials, manufacturing, and any other possible fault of the products, tolerances and usage excepted, will be solved with the simple change of the faulty parts, only after the evaluation of the Seller's Quality Department. At his own judgement the Seller have the right to close the issue with a credit note for the value of the faulty goods, with exception of any other possible collateral damage.

Only the claims coming to the Seller within 7 days from the delivery date will be considered. In any case the shipment of faulty goods must be previously agreed between the Parties, with particular attention to the transport costs.

Any goods coming back to Trafimet without the previous agreement of the Seller, will be sent back to sender at its own costs.

Art. 10 - Return of goods

Return of the goods and shipment charges must be previously agreed by the Seller. Goods returned without written authorization will be refused and sent back to the Buyer.

It is otherwise clear that only new and unused products, in perfect conditions and provided with original boxes can be returned to the Seller.

Art. 11 - No liability for late delivery

The Seller shall endeavor to complete the contract and/or deliver the goods within the time agreed (if any) but it shall not be liable for any loss or any kind of damage whatsoever caused directly or indirectly by any delay in completing of the contract or delivery of the products.

Art. 12 - Applicable law and settlement of disputes

All contracts with the Seller shall be deemed to have been made in Italy and shall in all respects be construed and interpreted in accordance with the Italian law.

Any dispute shall be referred to the Tribunal of Vicenza, provided however that the Seller, at its own discretion, may elect to waive the competence of the Italian law and the Tribunal of Vicenza to bring an action against the Buyer before any court of competent jurisdiction, in the domicile of the Buyer itself, the applicable law being the law of the country of the Buyer's domicile.

Art. 13 Validity

These sales conditions cancel and replace any other sales condition that could be mentioned in our documents, if the latter are different from the above mentioned conditions.

Garanzia di 2 anni per prodotto difettoso
Assicurazione RC prodotto difettoso per
circa Euro 3.000.000



2 Years' Warranty for defective products
Liability insurance for defective products
up to about Euro 3.000.000

**Trafimet Group Spa**

Via del Lavoro, 8
36020 Castegnero
Vicenza, Italy
Ph. +39 0444739900
Fax +39 0444739999
info@trafimet.com

TCS Sro

Rybnicna 38/G Street
83106 Bratislava
Slovakia
Ph. +42 1249112311
Fax +42 1249112301
info@trafimet.sk

**Jinan Trafimet Welding
& Cutting Tools Co. Ltd**

159-8 Industrial North Road
Jinan City, Shandong Province
China
Ph. +86 531 88010828
Fax +86 531 88010828604
info@trafimet.com.cn

Trafimet Schweisstechnik GmbH

Im Gewerbegebiet 20
36289 Friedewald
Deutschland
Ph. +49 66749000
Fax +49 667490028
info@trafimet.de

Trafimet Kaynak Sistemleri A.Ş.

İkitelli O.S.B. Heskoop H Blok
Sinpaş İş Modern Ticaret Merkezi
Kat3 no.66/1 Başakşehir 34306
İstanbul Türkiye
Ph. +90 212 8091700
Fax +90 212 8091703
info@trafimet.com.tr

**Trafimet Shanghai Welding
& Cutting Torches Co. Ltd**

20B01, No. 360, Heng Tong Road
200070 Shanghai
China
Ph. +86 2134040500/01
Fax +86 2152137765
shanghai@trafimet.com.cn

Trafimet France Sarl

Siège social
41-43 Rue Perier
92120 Montrouge - France
Ph. +33 380403010
Fax +33 380403011
trafimetfr@trafimet.com

Trafimet USA

2237 West 77th Street
Hialeah, FL 33016
USA
Ph. +1 786 309 9329
Mobile +1 305 282 7439
Toll free +1 800 535 1185
sales@trafimetusa.com

Representative office**Trafimet Nordic**

Stefan Lindqvist
Sales Manager Nordic
Ph. +46 304661020
Fax +46 304661020
Mobile +46 766114880
stefan.lindqvist@trafimet.se

**ITALY**

Ph. +39 0444 739800
Fax +39 0444 739899

EXPORT

Ph. +39 0444 739900
Fax +39 0444 739999

info@trafimetpro.com

Distributor